

0 1 2 3 4 5 6 7 8

A

B

C

D

E

F

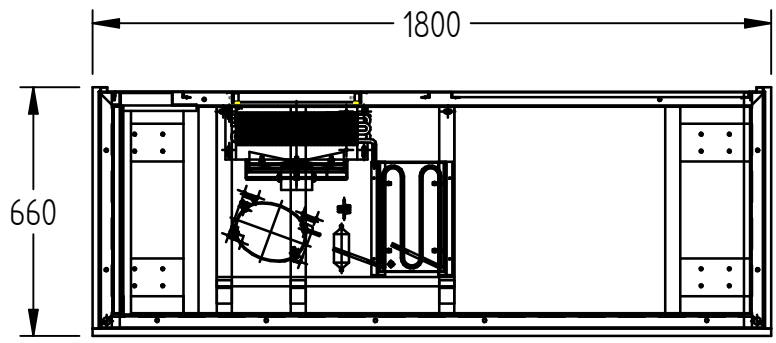
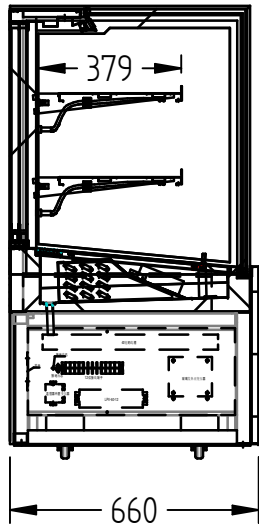
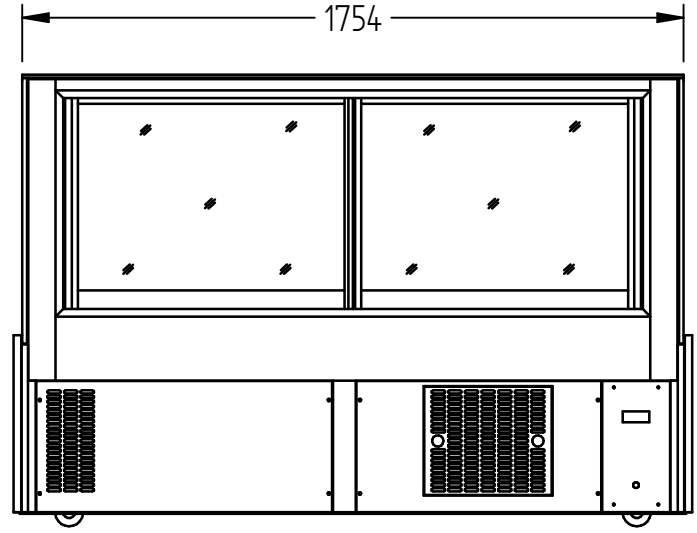
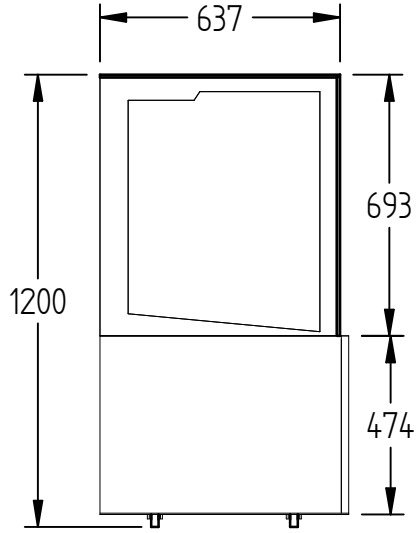
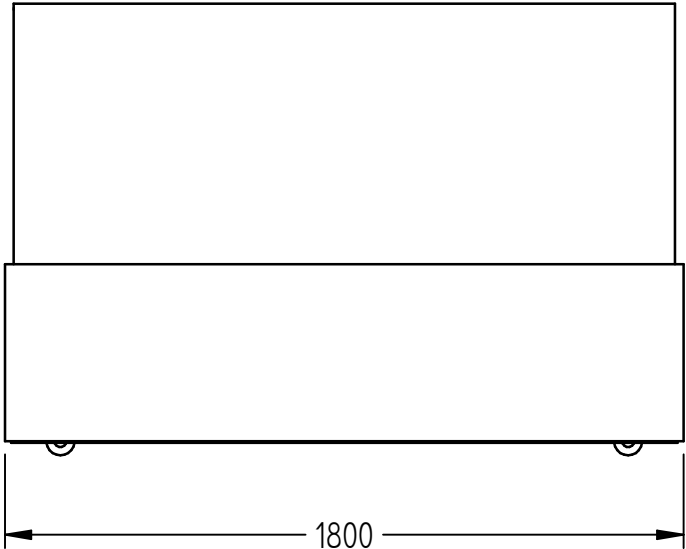

williams
REFRIGERATION AUST. PTY. LTD

This drawing and all copies produced remain the property of Williams Refrigeration and must not be copied or distributed by any third party without obtaining authorisation

UNLESS OTHERWISE STATED ALL DIMENSIONS IN MILLIMETERS.
GENERAL TOLERANCES:
UP TO 6 +/-0.1
7 TO 30 +/-0.2
31 TO 120 +/-0.3
121 TO 315 +/-0.5
316 TO 1000 +/-0.8
1000 & OVER +/-1.2
ANGULAR +/-1°
LINEAR

DRAWN: RANDY
DATE: 30 04 18
CHECKED:
DRAFTING STANDARD AS 1100

MATERIAL: -
MODEL: HTCF18
TITLE: CAKE DISPLAY

STOCK No. --
DWG: HTCF18

REV	DESCRIPTION	DATE	BY
-	-	-	-